

COVER

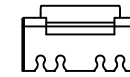

6 3 B A 5 4

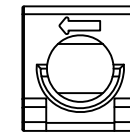
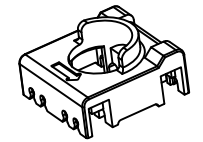

color code

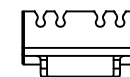

8 7 B A 2 1

enclosure

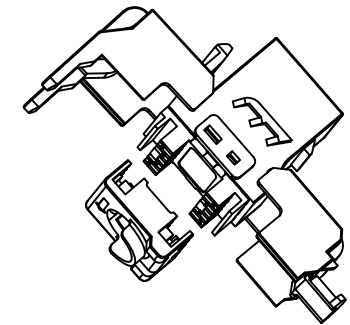
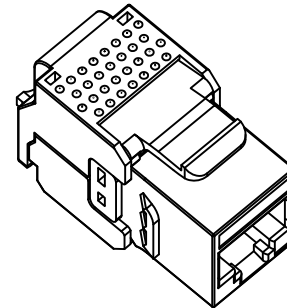
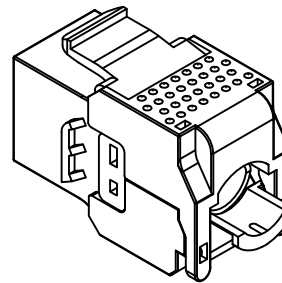
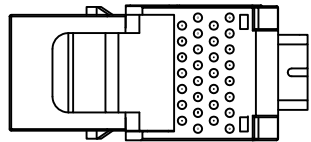
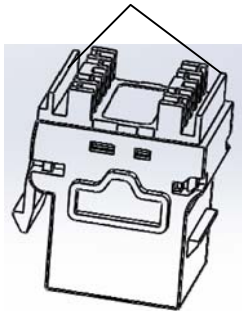

Specification:

Material:

- 1. JACK Housing :WHITE,PC/ABS,UL94-V0
- 2. RJ45 contact material & finished:
 - 2-1.Phosphor Bronze with Nickel plated.
 - 2-2.Contact area :Gold plated.

3.IDC Housing: PC ,UL94-V0

4.IDC Terminal material & finished:

- 4-1.Phosphor Bronze with Tin plated.
- 4-2. Toolless compatible.
- 4-3. Suitable for 22-26 AWG stranded and solid wire.

Performance:

- a.The sticker color codes combine two wirings of T568A & T568B.
- b.Insertion Force: 900 gms for 8 contacts.
- c.Retention Strength: 7.7 kgs between Jack and Plug.
- d.Operation Temperature: -20° to 68°.

e.Durability:

- e-1. Jack : 750 cycles Plug-Jack mating and unmating test, Insertion cycles at 20 cycles/minute max. Contact resistance test per 100 cycles.
- e-2. IDC : Max. 200 punching times.

f.The Cat.6 performance is in compliance with the ANSI/TIA/EIA 568 C standard.

		Tolerance:		SCALE:	CUSTOMER:		Approved by		
		X. ±0.5		FREE					
		.X ±0.3		UNIT:	CUSTOMER P/N:		COMPANY P/N:		
		.XX ±0.10		mm			01.075.0048		
		Angle:		REV.:	DWG. No.:		TITLE:		
		X° ±3°		00			UTP CAT6 KEYSTONE JACK TOOLLESS		
REV.		DESCRIPTION		DATE		SHEET		Design by	
						2:1		XJH	