

1 2 3 4 5 6 7

E

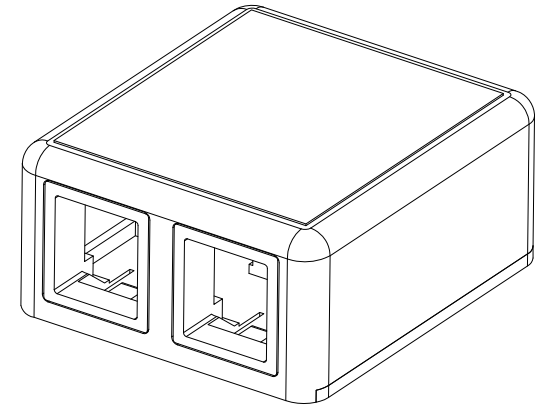

D

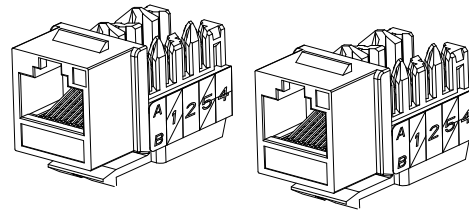
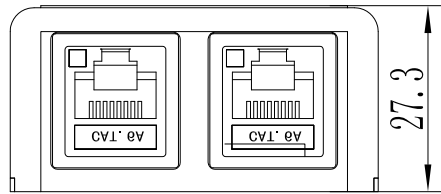
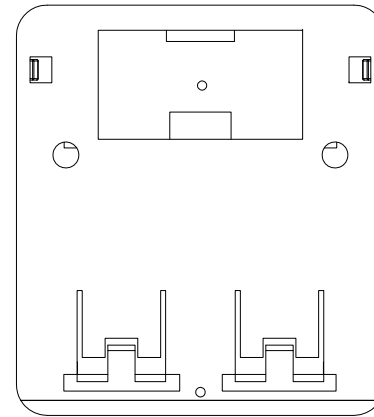
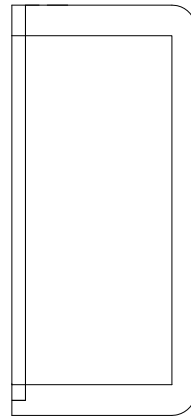
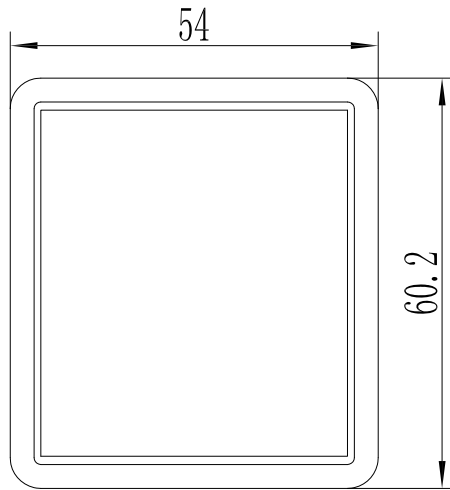
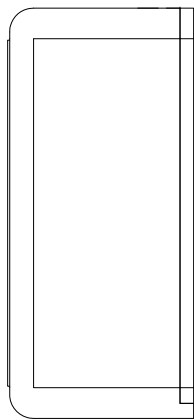

C

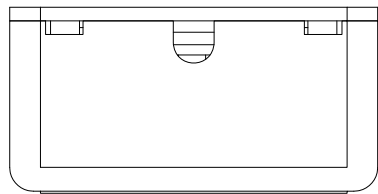

Specification:

Material:

- 1. BOX Housing :ABS UL 94-V0
- 2. JACK Housing :ABS UL 94-V0
- 3. RJ45 contact material & finished:
 - 3-1.Phosphor Bronze with Nickel plated.
 - 3-2.Contact area : Gold plated.

4.IDC Housing: PC UL 94-V0

- 5.IDC Terminal material & finished:
 - 5-1.Phosphor Bronze with Tin plated.
 - 5-2. 110 tool compatible.
 - 5-3. Suitable for 22-26 AWG stranded and solid wire.

Performance:

- a.The sticker color codes combine two wirings of T568A & T568B.
- b.Insertion Force: 900 gms for 8 contacts.
- c.Retention Strength: 7.7 kgs between Jack and Plug.
- d.Operation Temperature: -20° to 68°.

e.Durability:

- e-1. Jack : 750 cycles Plug-Jack mating and unmating test, Insertion cycles at 20 cycles/minute max. Contact resistance test per 100 cycles.
- e-2. IDC : Max. 200 punching times.
- f.The Cat.6A performance is in compliance with the ANSI/TIA/EIA 568 C.2 standard.

B

A

Tolerance:
X. ±0.5
.X ±0.3
.XX ±0.10

SCALE:
FREE

UNIT:
mm

Angle:
X° ±3°
.X° ±1°

REV.:
00

CUSTOMER:



SHEET 1/1

CUSTOMER P/N:

COMPANY P/N:
01.075.0112

DWG. No.:

TITLE: 2PORT UTP
CAT6A SURFACE BOX

Approved by

Checked by

Design by
XJH

REV.	DESCRIPTION	DATE

1 2 3 4 5 6 7