

COVER

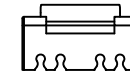

6 3 B A 5 4

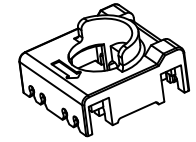

color code

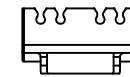
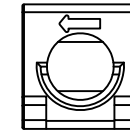

8 7 B A 2 1

enclosure

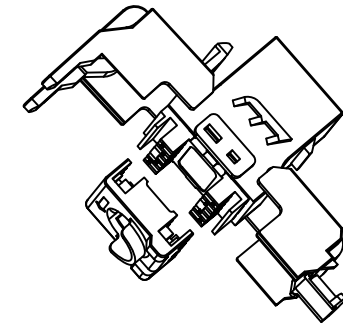
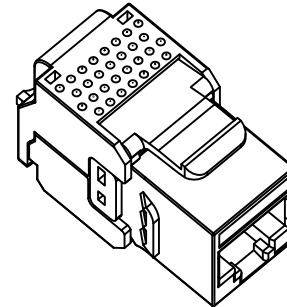
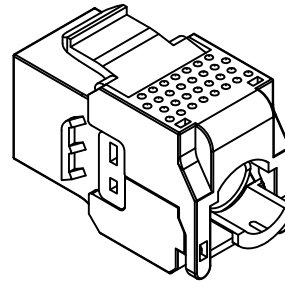
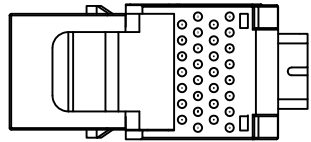
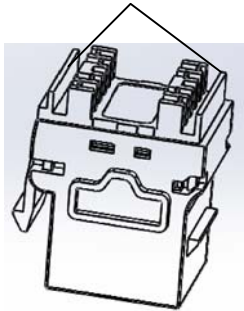

Specification:

Material:

- 1. JACK Housing :PC/ABS,WHITE
- 2. RJ45 contact material & finished:
 - 2-1.Phosphor Bronze with Nickel plated.
 - 2-2.Contact area :Gold plated.

3.IDC Housing: PC

4.IDC Terminal material & finished:

- 4-1.Phosphor Bronze with Tin plated.
- 4-2. Toolless compatible.
- 4-3. Suitable for 22-26 AWG stranded and solid wire.

Performance:

- a.The sticker color codes combine two wirings of T568A & T568B.
- b.Insertion Force: 900 gms for 8 contacts.
- c.Retention Strength: 7.7 kgs between Jack and Plug.
- d.Operation Temperature: -20° to 68°.

e.Durability:

- e-1. Jack : 750 cycles Plug-Jack mating and unmating test, Insertion cycles at 20 cycles/minute max. Contact resistance test per 100 cycles.
- e-2. IDC : Max. 200 punching times.

f.The Cat.6 performance is in compliance with the ANSI/TIA/EIA 568 C standard.

		Tolerance: X. ±0.5 .X ±0.3 .XX ±0.10		SCALE: FREE	CUSTOMER:		Approved by	
		Angle: X° ±3° .X° ±1°		UNIT: mm	CUSTOMER P/N:		COMPANY P/N: 01.075.0113	
REV.		DESCRIPTION		REV.:	DWG. No.:		TITLE: UTP CAT6 KEYSTONE JACK TOOLLESS	
		DATE		OO	SHEET 2:1		Design by XJH	