

Modules with protection against polarity inversion

model Type 22

Plug-in module, for mounting on ES15/4/2B - ES15/4/2G ES15/4/3/2N - ES15/4/3/2S ES50 - ES35 - ES32 - ES25 - ES50/3 - ES50/3S - ES35/3S - ES-50/3G with damping diode.

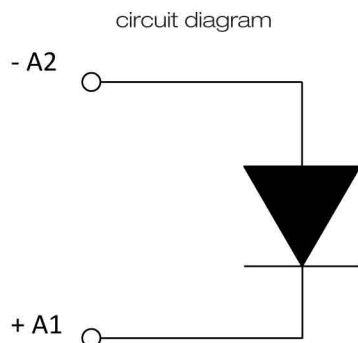

Electrical data	
Polarity	A1+ / A2-
Input voltage	6/230 VDC



ER900210
Pack. 200 pcs
MOQ 1000 pcs

dimension

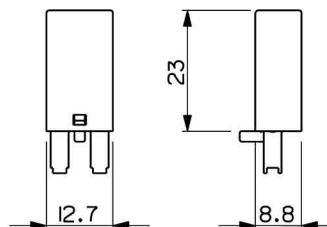

model Type 42

Plug-in module, for mounting on ES15/4/2B - ES15/4/2G - ES15/4/3/2N - ES15/4/3/2S ES50 - ES35 - ES32 - ES25 - ES50/3 - ES50/3S - ES35/3S - ES-50/3G with damping diode and red LED.

Electrical data	
Polarity	A1+ / A2-
Input voltage	6/24 VDC



ER900230
Pack. 200 pcs
MOQ 1000 pcs

model Type 42V

Plug-in module, for mounting on ES15/4/2B - ES15/4/2G - ES15/4/3/2N - ES15/4/3/2S ES50 - ES35 - ES32 - ES25 - ES50/3 - ES50/3S - ES35/3S - ES-50/3G with damping diode and green LED.

Electrical data	
Polarity	A1+ / A2-
Input voltage	6/24 VDC



ER901950
Pack. 200 pcs
MOQ 1000 pcs

model Type 42B

Plug-in module, for mounting on ES15/4/2B - ES15/4/2G - ES15/4/3/2N - ES15/4/3/2S ES50 - ES35 - ES32 - ES25 - ES50/3 - ES50/3S - ES35/3S - ES-50/3G with damping diode and red LED.

Electrical data	
Polarity	A1+ / A2-
Input voltage	24/60 VDC



ER901960
Pack. 200 pcs
MOQ 1000 pcs

model Type 42BV

Plug-in module, for mounting on ES15/4/2B - ES15/4/2G - ES15/4/3/2N - ES15/4/3/2S ES50 - ES35 - ES32 - ES25 - ES50/3 - ES50/3S - ES35/3S - ES-50/3G with damping diode and green LED.

Electrical data	
Polarity	A1+ / A2-
Input voltage	24/60 VDC



ER901970
Pack. 200 pcs
MOQ 1000 pcs

Standard article

Article on request

MOQ: minimum quantity order

circuit diagram

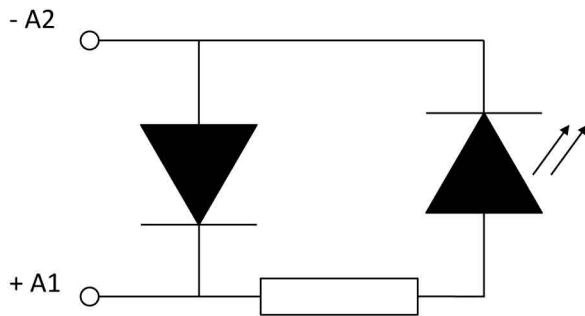

dimension

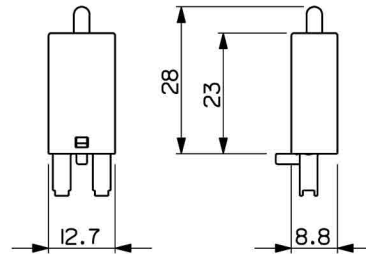

Modules with **RC Circuit**

model Type 52C

Plug-in module, for mounting on ES15/4/2B - ES15/4/2G - ES15/4/3/2N - ES15/4/3/2S ES50 - ES35 - ES32 - ES25 - ES50/3 - ES50/3S - ES35/3S - ES-50/3G with RC circuit.

Electrical data

Polarity	A1+ / A2-
Input voltage	110/230 VAC



ER902020

Pack. 200 pcs

MOQ 1000 pcs

circuit diagram

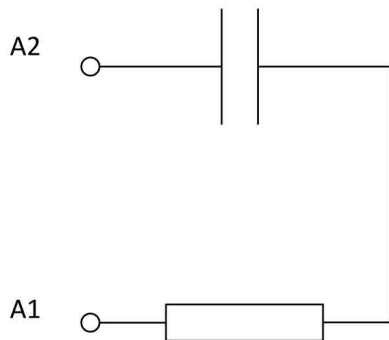

dimension

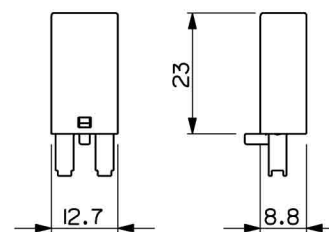

Modules with signaling circuits

model Type 62

Plug-in module, for mounting on ES15/4/2B - ES15/4/2G - ES15/4/3/2N - ES15/4/3/2S ES50 - ES35 - ES32 - ES25 - ES50/3 - ES50/3S - ES35/3S - ES-50/3G with red LED and without protections against polarity inversion.

model Type 62V

Plug-in module, for mounting on ES15/4/2B - ES15/4/2G - ES15/4/3/2N - ES15/4/3/2S ES50 - ES35 - ES32 - ES25 - ES50/3 - ES50/3S - ES35/3S - ES-50/3G with green LED and without protections against polarity inversion.

model Type 62B

Plug-in module, for mounting on ES15/4/2B - ES15/4/2G - ES15/4/3/2N - ES15/4/3/2S ES50 - ES35 - ES32 - ES25 - ES50/3 - ES50/3S - ES35/3S - ES-50/3G with red LED and without protections against polarity inversion.

model Type 62E

Plug-in module, for mounting on ES15/4/2B - ES15/4/2G - ES15/4/3/2N - ES15/4/3/2S ES50 - ES35 - ES32 - ES25 - ES50/3 - ES50/3S - ES35/3S - ES-50/3G with red LED and without protections against polarity inversion.

model Type 92

Plug-in module, for mounting on ES15/4/2B - ES15/4/2G - ES15/4/3/2N - ES15/4/3/2S ES50 - ES35 - ES32 - ES25 - ES50/3 - ES50/3S - ES35/3S - ES-50/3G with red LED and without protections against polarity inversion.

model Type 92V

Plug-in module, for mounting on ES15/4/2B - ES15/4/2G - ES15/4/3/2N - ES15/4/3/2S ES50 - ES35 - ES32 - ES25 - ES50/3 - ES50/3S - ES35/3S - ES-50/3G with green LED and without protections against polarity inversion.

Electrical data	
Polarity	A1+ / A2-
Input voltage	6/24 VAC\VDC

ER900250
Pack. 200 pcs
MOQ 1000 pcs

Electrical data	
Polarity	A1+ / A2-
Input voltage	6/24 VAC\VDC

ER902030
Pack. 200 pcs
MOQ 1000 pcs

Electrical data	
Polarity	A1+ / A2-
Input voltage	24/60 VDC

ER900670
Pack. 200 pcs
MOQ 1000 pcs

Electrical data	
Polarity	A1+ / A2-
Input voltage	24/60 VAC\VDC

ER902040
Pack. 200 pcs
MOQ 1000 pcs

Electrical data	
Polarity	A1+ / A2-
Input voltage	110/230 VAC\VDC

ER900280
Pack. 200 pcs
MOQ 1000 pcs

Electrical data	
Polarity	A1+ / A2-
Input voltage	110/230 VAC\VDC

ER902100
Pack. 200 pcs
MOQ 1000 pcs

circuit diagram

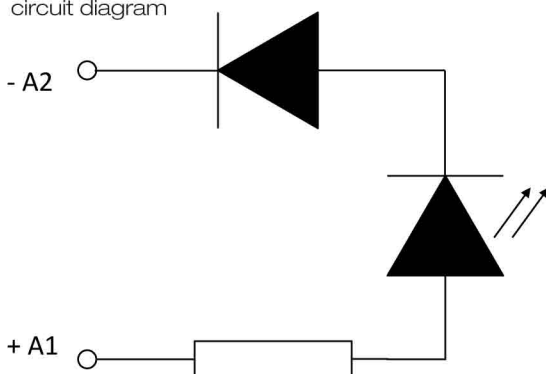

dimension

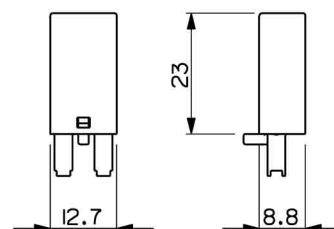

Standard article Article on request MOQ: minimum quantity order

Modules with signaling circuits and varistor

model Type 62C

Plug-in module, for mounting on ES15/4/2B - ES15/4/2G - ES15/4/3/2N - ES15/4/3/2S ES50 - ES35 - ES32 - ES25 - ES50/3 - ES50/3S - ES35/3S - ES-50/3G with varistor and red LED.

Electrical data

Polarity	A1+ / A2-
Input voltage	6/24 VAC/VDC



ER902060

Pack. 200 pcs
MOQ 1000 pcs

model Type 62CV

Plug-in module, for mounting on ES15/4/2B - ES15/4/2G - ES15/4/3/2N - ES15/4/3/2S ES50 - ES35 - ES32 - ES25 - ES50/3 - ES50/3S - ES35/3S - ES-50/3G with varistor and green LED.

Electrical data

Polarity	A1+ / A2-
Input voltage	6/24 VAC/VDC



ER902070

Pack. 200 pcs
MOQ 1000 pcs

model Type 62DV

Plug-in module, for mounting on ES15/4/2B - ES15/4/2G - ES15/4/3/2N - ES15/4/3/2S ES50 - ES35 - ES32 - ES25 - ES50/3 - ES50/3S - ES35/3S - ES-50/3G with varistor and green LED.

Electrical data

Polarity	A1+ / A2-
Input voltage	24/60 VAC/VDC



ER902090

Pack. 200 pcs
MOQ 1000 pcs

model Type 92C

Plug-in module, for mounting on ES15/4/2B - ES15/4/2G - ES15/4/3/2N - ES15/4/3/2S ES50 - ES35 - ES32 - ES25 - ES50/3 - ES50/3S - ES35/3S - ES-50/3G with varistor and red LED.

Electrical data

Polarity	A1+ / A2-
Input voltage	110/230 VAC/VDC



ER902110

Pack. 200 pcs
MOQ 1000 pcs

model Type 92CV

Plug-in module, for mounting on ES15/4/2B - ES15/4/2G - ES15/4/3/2N - ES15/4/3/2S ES50 - ES35 - ES32 - ES25 - ES50/3 - ES50/3S - ES35/3S - ES-50/3G with varistor and green LED.

Electrical data

Polarity	A1+ / A2-
Input voltage	110/230 VAC/VDC



ER902120

Pack. 200 pcs
MOQ 1000 pcs

circuit diagram

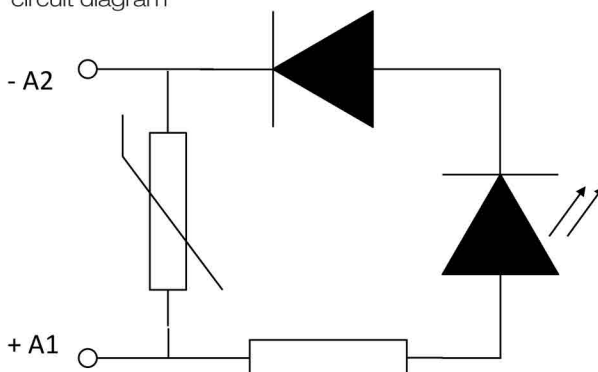

dimension

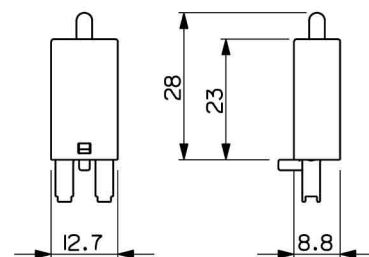

Standard article
 Article on request
 MOQ: minimum quantity order