

WR

Rating: 20A 125V AC (UL CUL)
22A 250V AC (ENEC CB CQC)

Degree of protection: IP65;

Contact Resistance: 50m Ω Max

Insulation Resistance: DC 500V 100M Ω Min.

Dielectric Strength: AC1500V 1 minute

Operating Force: 600±150gf

Mechanical Life: Over 30,000 cycles

Electrical Life: Over 10,000 cycles

Operating Temperature: 0 °C~85 °C

Safety Approval:

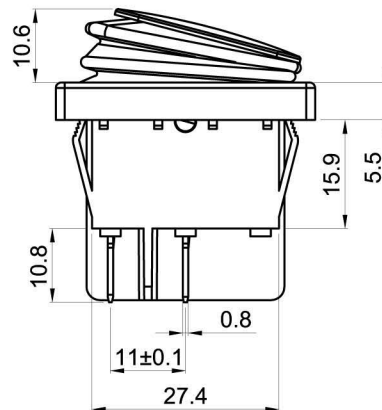
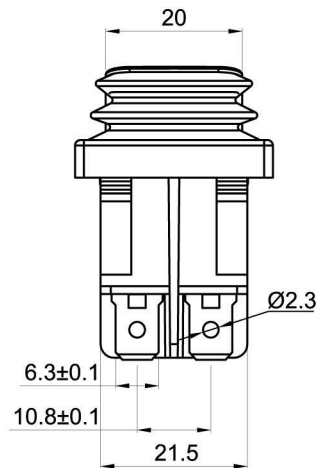
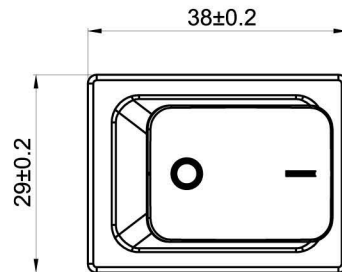

CUT-OUT

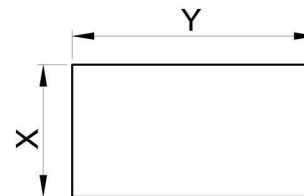

	X	Y
0.75~1.25	22.0+0.1	30.0+0.1
1.25~2.00	22.0+0.1	30.2+0.1
2.00~3.00	22.0+0.1	30.4+0.1

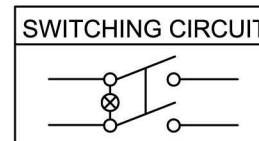

WR-210-P5L-BG
01.086.0122

MATERIAL:

Body:Nylon66,UL rated:94V-2 min.

Actuator:PC

Terminal:Brass,silver or tin plated