

WR-6

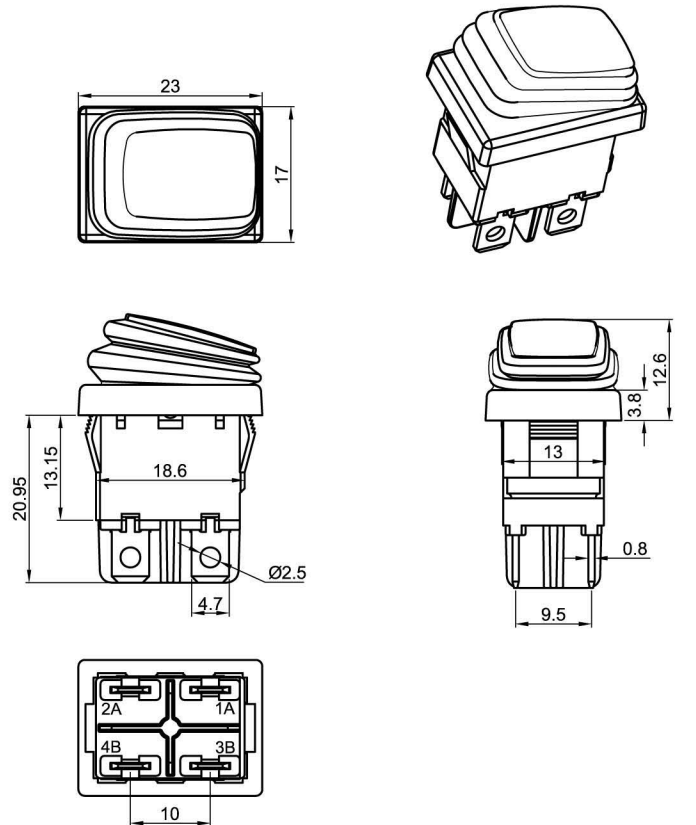

Rating: 12A 125V AC(UL CUL) ;
 10A 250V AC(ENEC CQC) ;
 Degree of protection:IP65;
 Contact Resistance: 50mΩ Max. ;
 Insulation Resistance:DC 500V 100MΩ Min. ;
 Dielectric Strength:AC 1500V 1 minute
 Operating Force:600± 150gf
 Mechanical Life:50,000 cycles
 Load Life:10,000 cycles
 Operating Temperature: 0 °C~85 °C

CUT-OUT

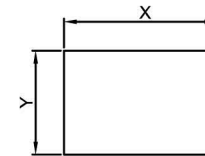

	X	Y
0.75~1.25	19.2+0.1	13.0+0.1
1.25~2.00	19.4+0.1	13.0+0.1
2.00~3.00	19.8+0.1	13.0+0.1

MATERIAL:

Body:Nylon66,UL rated:94V-2 min
 Actuator:PC
 Terminal:Brass,silver plated

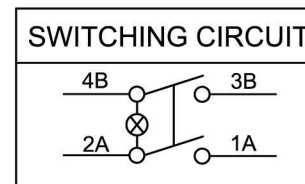

WR6-210-PXL-BR-220
 01.086.0126