

WR-1

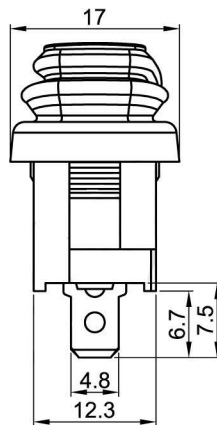

Rating: 12A 125V AC(UL CUL) ;
 10A 250V AC(ENEC CQC) ;
 Degree of protection: IP65;
 Contact Resistance: 50mΩ Max. ;
 Insulation Resistance:DC 500V 100MΩ Min. ;
 Dielectric Strength:AC 1500V 1 minute
 Operating Force:600± 150gf
 Mechanical Life:50,000 cycles
 Load Life:10,000 cycles
 Operating Temperature: 0°C~85°C

CUT-OUT

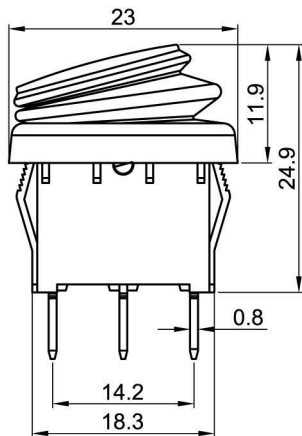
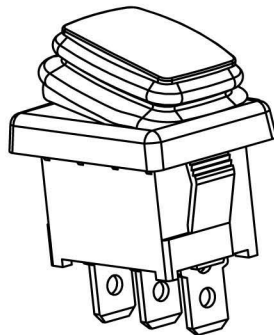
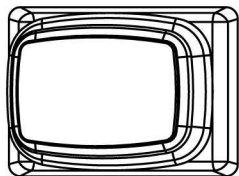
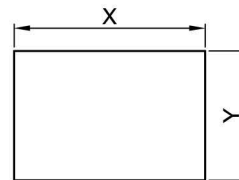

	X	Y
	19.2-0.1	13.0+0.1
	19.4-0.1	13.0+0.1
	19.8-0.1	13.0+0.1

WR1-110-PXL-BR-220

01.086.0130

MATERIAL:

Body:Nylon66,UL rated:94V-2 min.

Actuator:PC.

Terminal:Brass,silver or tin plated.

